

PTED/PTER/PTES Series

Remotely autozero by shorting two pins together
Several amplified signal output are optional



Certification :

ISO9001-2015



Content

- 1. Introduction _____
- 2. Application _____
- 3. Product Features _____
- 4. Technical data _____
- 5. Dimensions _____
- 6. Electrical connection and debugging _____
- 7. Ordering Guide _____
- 8. Installation and Removal _____
- 9. Sensors cleaning _____
- 10. Transport and Storage _____

1. Introduction

PTED/PTER/PTES series adopt imported stainless steel materials, core elements and digital mode circuit design. Realizing sensor linear compensation through digital program. Remote autozero via shorting two pins together. Comply with SIL2, CE safety performance standards. High precision, high stability, low temperature drift and other performance characteristics.

2. Application

PTED/PTER/PTES series is suitable for high-precision extrusion polymerization process control for sheets, composites, films, pipes, chemical raw materials, etc.

3. Product Features

Several amplified signal output are optional Remotely autozero

Good stability and anti-interference ability Internal 80% self-calibration

4. Technical Data

Pressure Range	0~35bar;0~2000bar		0~100bar;0~2000bar
Accuracy	±0.5%、±0.25%		
Over load Pressure	1.5FSO		
Bridge Resistance	350ΩWheatstone bridge		
Power	12 ~ 36Vdc (Standard24Vdc)		10Vdc
Output Signal	4 ~ 20mA	0 ~ 10Vdc 0 ~ 5 Vdc	3.33mV/V
Load Resistance (Ω)	< (U-12) /0.02	> 10K	
Calibration	80%FSO		
Process Connection	M14×1.5、1/2-20UNF、M18×1.5		
Insulation Resistance (50Vdc)	1000MΩ		
Diaphragm Material	17-4PH、inconel718、C276		
Diaphragm max temp	400C°		
Film Material	TiAlN		
E-connection	6-pin connector(Standard),8-pin connector		
Electrical Environment temp	-20C° ~ 85C°		
Thermocouple	J Type,E Type,K Type,pt100		
Protection degree	IP65		
Installation torque	< 30Nm		
Filling Material	Mercury filling		

5. Dimensions

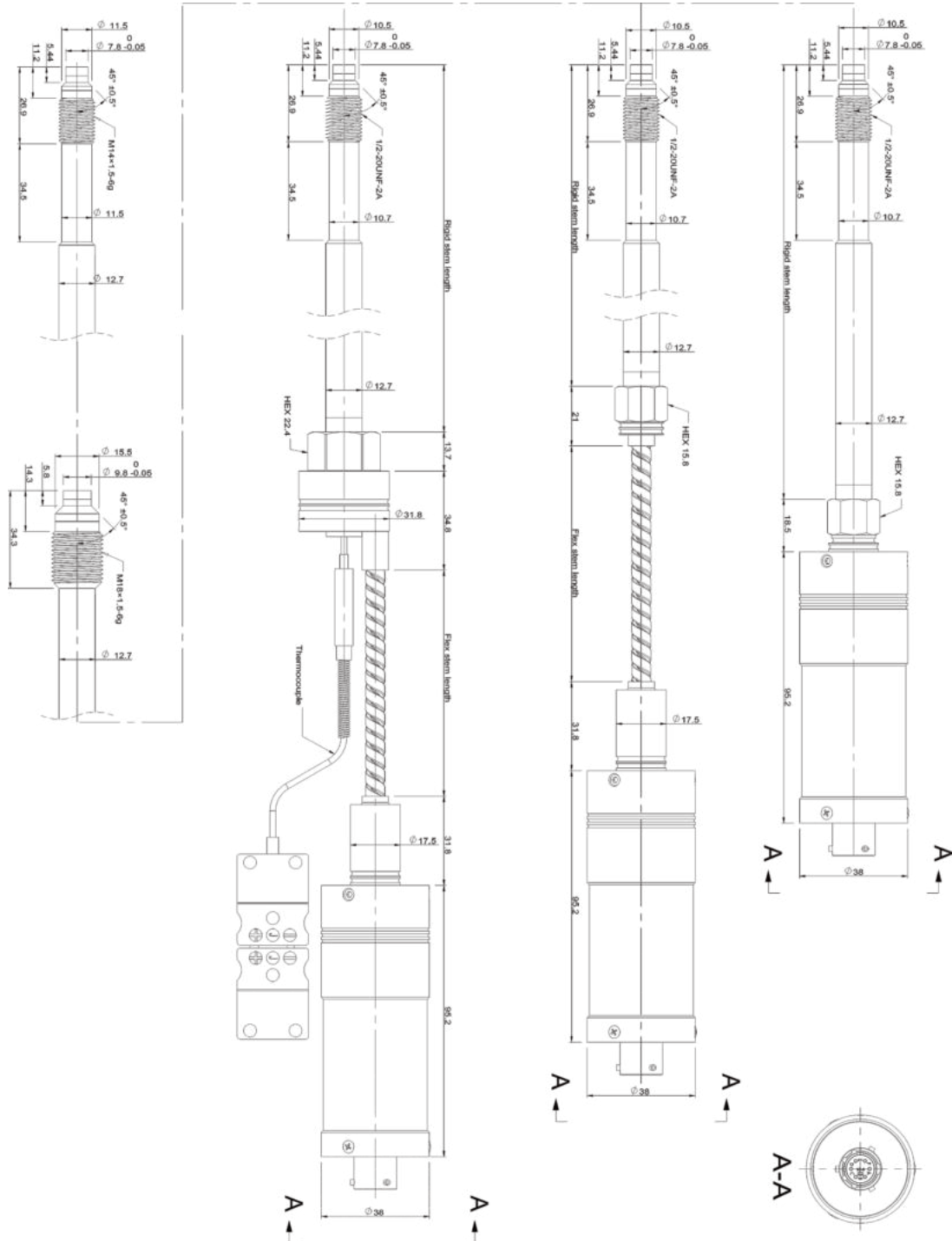

6. Electrical connection & Debugging

After the pressure sensor has been installed on the pipeline, the electrical connection must be made in accordance with the connection method shown in the wiring diagram below.

The PTED/PTER/PTES pressure sensor is equipped with an integrated amplifier circuit. The calibration process must be carried out when the pipeline is heated and the pressure is zero. The zero point is adjusted by activating the autozero function, which is started via shorting two pins together. Start by connecting (see wiring), mV signal does not have this function temporarily, it can be reset to zero through the back-end instrument. Then 80% of the output signal is detected (see wiring diagram), and the pressure sensor will provide a standard 80% measured value signal.

3.33mV/V Output (4-wire)

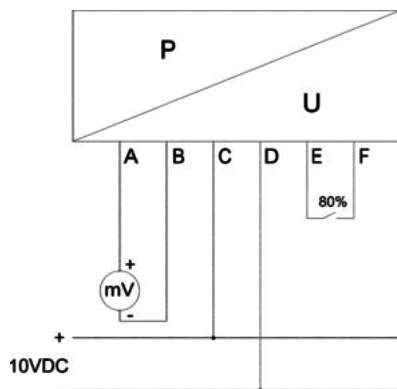

6-pin connector / PT02A-10-6P

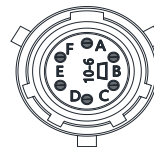

PIN	Function	Wire Color
A	Signal +	Red
B	Signal -	Black
C	Power +	White
D	Power -	Green
E	80% +	Blue
F	80% -	Orange

4...20mA Output (2-wire)

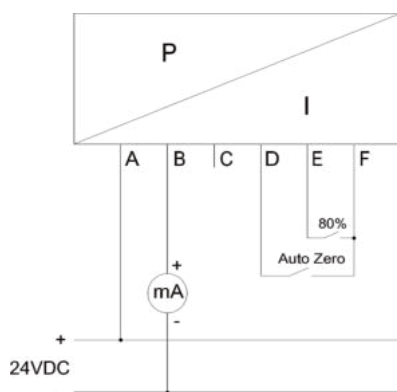

6-pin connector / PT02A-10-6P

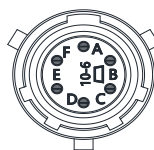

PIN	Function	Wire Color
A	Power +	Red
B	Power -	Black
C		White
D	Shorting D&F to rezero +	Green
E	80% +	Blue
F	Shorting D&F to rezero - /80% -	Orange

0...5V / 0...10V (4-wire)

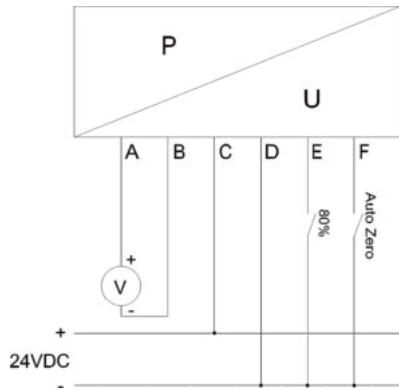

6-pin connector / PT02A-10-6P.

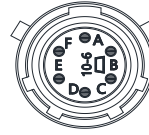

PIN	Function	Wire Color
A	Signal +	Red
B	Signal -	Black
C	Power +	White
D	Power - /80% - /Shorting D&F to rezero -	Green
E	80% +	Blue
F	Shorting D&F to rezero +	Orange

* B and D pins are connected internally

It must be a shielded cable, each core wire is about 0.3mm², the heat-resistant temperature is not less than 105C°, each core wire connection terminal should be insulated and protected by heat shrinkable tube, the shielding wire should be connected with the plug-in metal, and the cable should be specially welded carefully, otherwise it may cause signal transmission errors or damage the product. It is recommended to use a dedicated cable that has been soldered by Ziasiot. For extra wires in the cable, each wire needs to be individually wrapped with insulating tape.

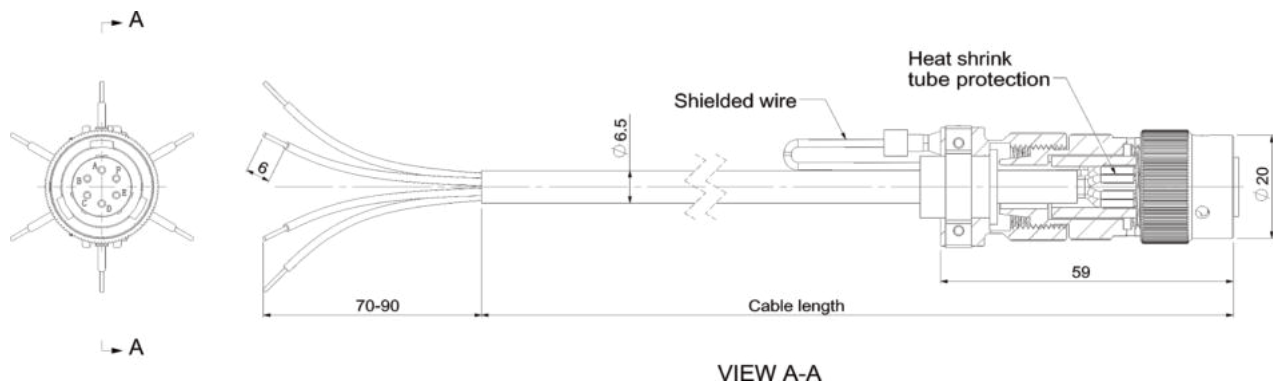

7. Ordering Guide

Serie No	PTE	X	-	X	-	X	-	X	X	-	X	-	X	-	X	-	X
Product Type	Rigid Stem	D															
	Rigid+flexible stem	R															
	With thermocouple	S															
Pressure Range	3.5MPa 35bar 500psi																
	10MPa 100bar 1500psi																
	20MPa 200bar 3000psi																
	35MPa 350bar 5000psi																
	50MPa 500bar 7500psi																
	70MPa 700bar 10000psi																
	100MPa 1000bar 15000psi																
	200MPa 2000bar 30000psi																
Process Connction	1/2-20UNF																
	M14×1.5																
	M18×1.5																
Rigid stem Length	6" (152mm)																
	9" (229mm)																
	12.5" (318mm)																
	15" (381mm)																
	18" (460mm)																
Flexible stem Length	18" (460mm)																/18
	24" (610mm)																/24
	30" (760mm)																/30
Output Signal	4 ~ 20mA																MA
	0 ~ 10Vdc																10V
	3.33mV/V																MV
E-connection	6-pin aviation Connector																--
	8-pin aviation Connector (Interchange with p/n 711600)																8P
Thermocouple	J Type																J
	K Type																K
	E Type																E
	Pt100																RTD1
Accuracy	0.50%																--
	0.25%																2A
Diaphragm	17-4PH(Standard)																--
	Inconel718 (Anti-abrasive)																I7
	C276 (Anti-corrosive)																C2

8. Installation & Removal

Installation

When installing the pressure sensor, the sensor hole should be within the size requirement marked in following drawing and the assembly accuracy can be checked by testing bolts. Before installing the sensor, first clean the impurities in the hole and between the threads, then the thread of the sensor is coated with heat-resistant slurry, the screw teeth can be avoided.

The installation force is very important, the installation torque of the sensor can only act on the shaft (hexagon), do not apply any force to the head of the sensor. The housing should be kept away from high temperature areas.

1/2-20 UNF /M14×1.5= Maximum starting torque: 40Nm

M18 x 1.5 = Maximum starting torque: 50 Nm

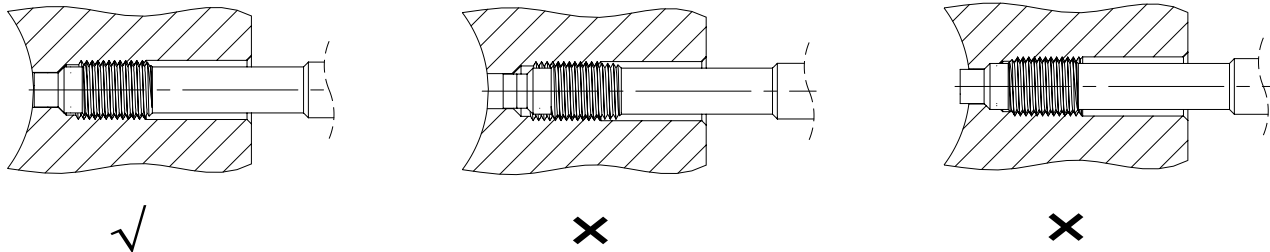

Removal

The removal of sensor must be done under heated conditions (plastic melting point). When remove the sensor, please note that the diaphragm has no contact pressure. The force to remove the sensor must only be applied on the shaft (hexagon), and do not apply any force to the head of the sensor.

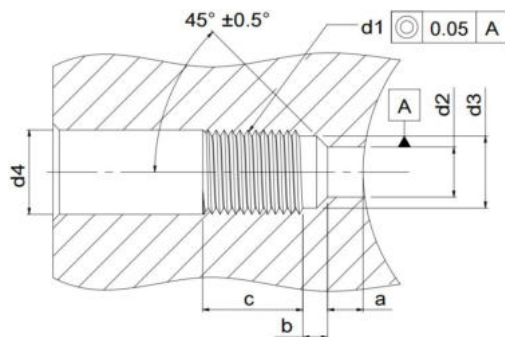

d1	M18×1.5	M14×1.5	1/2-20UNF-2A
d2	Ø9.9 ^{+0.1}	Ø7.9 ^{+0.1}	Ø7.9 ^{+0.1}
d3	Ø16.1 ^{+0.1}	Ø11.7 ^{+0.1}	Ø10.7 ^{+0.1}
d4	Ø20	Ø15	Ø14
a	6.1 ^{-0.1}	5.7 ^{-0.1}	5.7 ^{-0.1}
b	4 ^{-0.2}	3.2 ^{-0.2}	3.2 ^{-0.2}
c	25	19	19

9. Sensors cleaning

In order to clean the diaphragm, the sealing surface and thread of the sensor must have the same temperature as the melting point of the plastic. Both the diaphragm and the sealing surface can be wiped clean with a soft cloth, and the thread can be cleaned with a steel brush or a copper brush. . (Do not touch the surface of the diaphragm with the steel brush)

10. Transport and storage

The PTED/PTER/PTES series is usually packaged separately. The front thread of the rigid stem and the diaphragm is protected by a protective cap. This protective cap should be tightened at any time during storage, and only opened during installation.

Notes: Mounting brackets,extension cables,connectors,cleaning kits,drill kits,dummy plug etc accessories,please contact with us.